

APPENDIX A

CURRENT TOLL SCHEDULES

Department-owned FacilitiesPage A-2
Department-operated FacilitiesPage A-4

PLAZA CONFIGURATIONS - DEPARTMENT-OWNED FACILITIES

Alligator AlleyPage A-6
Beachline East ExpresswayPage A-7
Pinellas Bayway SystemPage A-9
Sunshine Skyway BridgePage A-10
95 ExpressPage A-11

PLAZA CONFIGURATIONS - DEPARTMENT-OPERATED FACILITIES

Garcon Point BridgePage A-12
Mid-Bay Bridge.....Page A-13

ENTERPRISE TOLL OPERATIONS

**Current Toll Schedules
Department-owned Toll Facilities
SunPass**

Facility	Location	Ramps To/From	Toll Per Axle					
			2-Axle	3-Axle	4-Axle	5-Axle	6-Axle	Add'l Axles
Alligator Alley	Junction with CR 951	-	Alligator Alley Western Terminus					
	West Plaza	-	\$2.81	\$5.62	\$8.43	\$11.24	\$14.05	\$2.81
	SR 29	E-W	No toll at this location					
	CR 833 (Reservation)	E-W	No toll at this location					
	East Plaza	-	\$2.81	\$5.62	\$8.43	\$11.24	\$14.05	\$2.81
	Junction with US 27	-	Alligator Alley Eastern Terminus					
Beachline East Expressway	Dallas Mainline Plaza ⁽¹⁾	-	\$0.76	\$1.01	\$1.26	\$1.26	\$1.26	\$0.00
	SR 520	West	No toll at this location					
		East	\$0.26	\$0.26	\$0.26	\$0.26	\$0.26	\$0.00
	North I-95 Interchange	E-W	No toll at this location					
	Junction with SR 405	-	North Beachline East Expressway Terminus					
	South I-95 Interchange	E-W	No toll at this location					
Junction with US 1	-	South Beachline East Expressway Terminus						
Pinellas Bayway System	Junction with SR 699	-	Pinellas Bayway Western Terminus					
	West Plaza	-	\$0.51	\$1.02	\$1.53	\$2.04	\$2.55	\$0.51
	South Plaza	-	\$0.26	\$0.52	\$0.78	\$1.04	\$1.30	\$0.26
	East Plaza	-	\$0.51	\$1.02	\$1.53	\$2.04	\$2.55	\$0.51
	Junction with US 19	-	Pinellas Bayway Eastern Terminus					
Sunshine Skyway Bridge	North Plaza	-	\$1.02	\$2.04	\$3.06	\$4.08	\$5.10	\$1.02
	South Plaza	-	\$1.02	\$2.04	\$3.06	\$4.08	\$5.10	\$1.02
95 Express ⁽²⁾	NW 54 th Street	-	\$0.25	N/A	N/A	N/A	N/A	N/A
	NW 144 th Street	-	\$0.25	N/A	N/A	N/A	N/A	N/A

Note: The toll rates above reflect the most current rates as of the July 1, 2013 (FY 2014) toll rate increase. The toll rates for SunPass customers may be lower depending on the discount program or annual pass program of the respective facility.

- (1) The Department's toll of \$0.26 is collected at OOCEA's Dallas Mainline Plaza.
- (2) Actual toll rate varies based on traffic density. 95 Express lanes are designed for 2-axle vehicles only.

**Current Toll Schedules
Department-owned Toll Facilities
Cash**

Facility	Location	Ramps To/From	Toll Per Axle					
			2-Axle	3-Axle	4-Axle	5-Axle	6-Axle	Add'l Axles
Alligator Alley	Junction with CR 951	-	Alligator Alley Western Terminus					
	West Plaza	-	\$3.00	\$6.00	\$9.00	\$12.00	\$15.00	\$3.00
	SR 29	E-W	No toll at this location					
	CR 833 (Reservation)	E-W	No toll at this location					
	East Plaza	-	\$3.00	\$6.00	\$9.00	\$12.00	\$15.00	\$3.00
	Junction with US 27	-	Alligator Alley Eastern Terminus					
Beachline East Expressway	Dallas Mainline Plaza ⁽¹⁾		\$1.00	\$1.25	\$1.50	\$1.50	\$1.50	\$0.00
	SR 520	West	No toll at this location					
		East	\$0.50	\$0.50	\$0.50	\$0.50	\$0.50	\$0.00
	North I-95 Interchange	E-W	No toll at this location					
	Junction with SR 405	-	North Beachline East Expressway Terminus					
	South I-95 Interchange	E-W	No toll at this location					
Junction with US 1	-	South Beachline East Expressway Terminus						
Pinellas Bayway System	Junction with SR 699	-	Pinellas Bayway Western Terminus					
	West Plaza	-	\$0.75	\$1.50	\$2.25	\$3.00	\$3.75	\$0.75
	South Plaza	-	\$0.50	\$1.00	\$1.50	\$2.00	\$2.50	\$0.50
	East Plaza	-	\$0.75	\$1.50	\$2.25	\$3.00	\$3.75	\$0.75
	Junction with US 19	-	Pinellas Bayway Eastern Terminus					
Sunshine Skyway Bridge	North Plaza	-	\$1.25	\$2.50	\$3.75	\$5.00	\$6.25	\$1.25
	South Plaza	-	\$1.25	\$2.50	\$3.75	\$5.00	\$6.25	\$1.25
95 Express ⁽²⁾	NW 54 th Street	-	N/A	N/A	N/A	N/A	N/A	N/A
	NW 144 th Street	-	N/A	N/A	N/A	N/A	N/A	N/A

Note: The toll rates above reflect the most current rates as of the July 1, 2013 (FY 2014) toll rate increase.

- (1) The Department's toll of \$0.50 is collected at OOCEA's Dallas Mainline Plaza.
(2) 95 Express is a SunPass-only facility.

ENTERPRISE TOLL OPERATIONS

**Current Toll Schedules
Department-operated Toll Facilities
SunPass**

Facility	Location	Ramps To/From	Toll Per Axle					
			2-Axle	3-Axle	4-Axle	5-Axle	6-Axle	Add'l Axles
Garcon Point Bridge	Junction with CR 191	-	Garcon Point Northern Terminus					
	Toll Plaza	-	\$3.75	\$7.50	\$11.25	\$15.00	\$18.75	\$3.75
	Junction with US 98	-	Garcon Point Southern Terminus					
Mid-Bay Bridge	Connector Toll Plaza	-	\$1.00	\$3.00	\$4.50	\$6.00	\$7.50	\$1.50
	Junction with SR 20	-	Mid-Bay Bridge Northern Terminus					
	Mainline Toll Plaza	-	\$2.00	\$6.00	\$9.00	\$12.00	\$15.00	\$3.00
	Junction with US 98	-	Mid-Bay Bridge Southern Terminus					

Note: The toll rates for SunPass customers may be lower depending on the discount program or annual pass program of the respective facility.

**Current Toll Schedules
Department-operated Toll Facilities
Cash/TOLL-BY-PLATE***

Facility	Location	Ramps To/From	Toll Per Axle					
			2-Axle	3-Axle	4-Axle	5-Axle	6-Axle	Add'l Axles
Garcon Point Bridge	Junction with CR 191	-	Garcon Point Northern Terminus					
	Toll Plaza	-	\$3.75	\$7.50	\$11.25	\$15.00	\$18.75	\$3.75
	Junction with US 98	-	Garcon Point Southern Terminus					
Mid-Bay Bridge	Connector Toll Plaza ⁽¹⁾	-	\$1.50	\$3.00	\$4.50	\$6.00	\$7.50	\$1.50
	Junction with SR 20	-	Mid-Bay Bridge Northern Terminus					
	Mainline Toll Plaza	-	\$3.00	\$6.00	\$9.00	\$12.00	\$15.00	\$3.00
	Junction with US 98	-	Mid-Bay Bridge Southern Terminus					

* TOLL-BY-PLATE toll rates in effect on Mid-Bay Bridge Connector.

(1) The Mid-Bay Bridge Connector is SunPass only.

ALLIGATOR ALLEY (Everglades Parkway)

East and West Plazas

ALLIGATOR ALLEY EAST - PLAZA NO. 106100

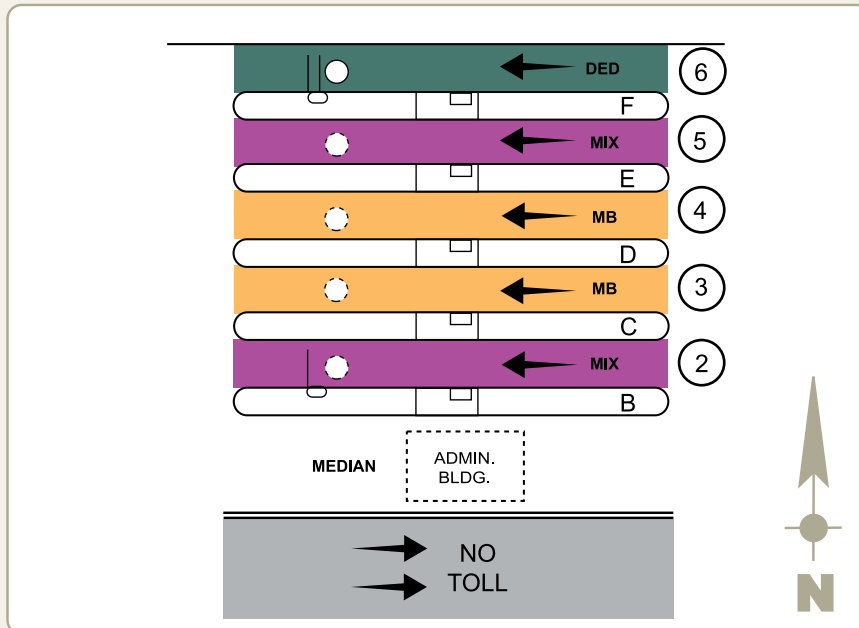

ALLIGATOR ALLEY WEST - PLAZA NO. 106200

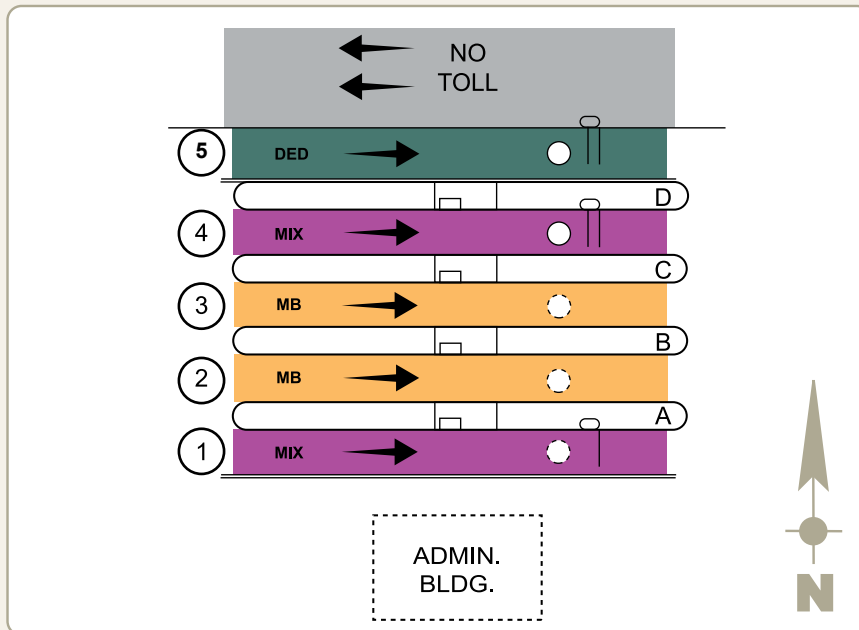

LEGEND

DED:	Dedicated SunPass Lane
MB:	Manual Booth Lane
MIX:	Manual Booth and SunPass Lane

FARE STRUCTURE

AXLES	(As of 7/1/13)	
	SUNPASS	CASH
2	\$2.81	\$3.00
3	\$5.62	\$6.00
4	\$8.43	\$9.00
5	\$11.24	\$12.00
ADDITIONAL	\$2.81	\$3.00

BEACHLINE EAST EXPRESSWAY
Dallas Mainline Plaza (OOCEA)

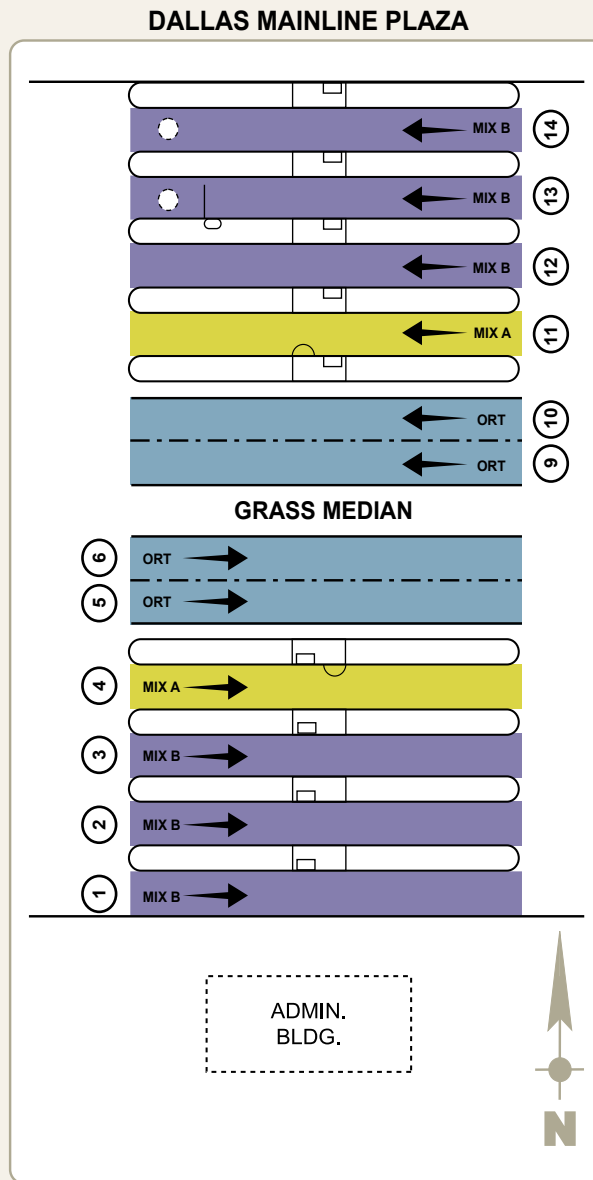

LEGEND

- ORT:** Open Road Tolling Lane/E-Pass Lane
- MIX A:** Automatic Coin and SunPass/E-Pass Lane
- MIX B:** Manual Booth and SunPass/E-Pass Lane

FARE STRUCTURE

AXLES	(As of 7/1/13)	
	SUNPASS	CASH
2	\$0.76	\$1.00
3	\$1.01	\$1.25
4	\$1.26	\$1.50
5 or more	\$1.26	\$1.50

BEACHLINE EAST EXPRESSWAY

SR 520 East Ramps

SR 520 NORTH OFF-RAMP - PLAZA NO. 103321

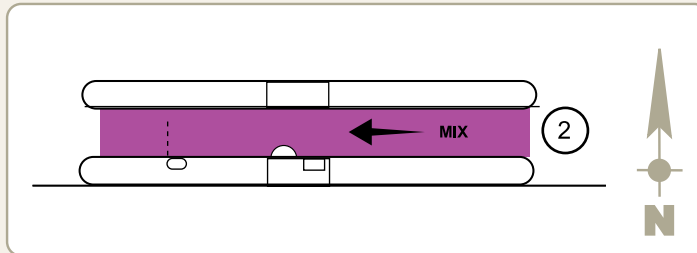

SR 520 SOUTH ON-RAMP - PLAZA NO. 103321

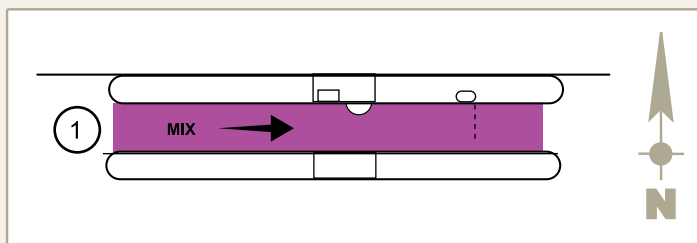

LEGEND

MIX: Automatic Coin, SunPass and E-Pass

FARE STRUCTURE

(As of 7/1/13)

SUNPASS	CASH
\$0.26	\$0.50

All Axle Classes

PINELLAS BAYWAY SYSTEM

PINELLAS BAYWAY I (MAIN) - PLAZA NO. 101300

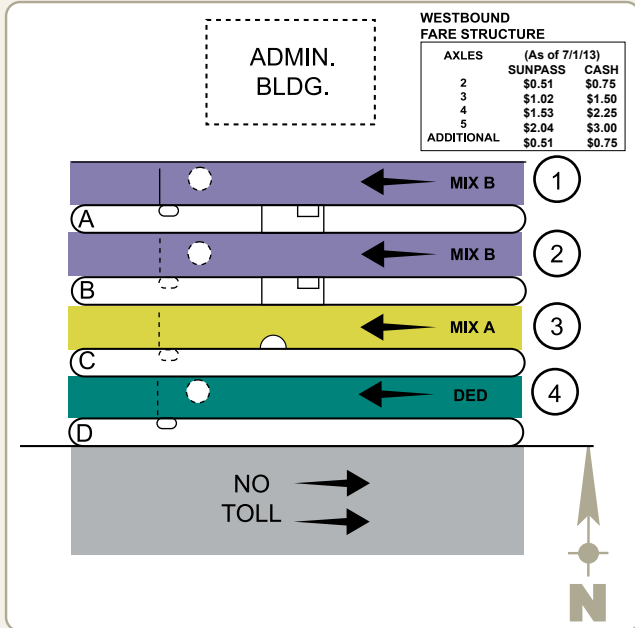

PINELLAS BAYWAY II - PLAZA NO. 101310

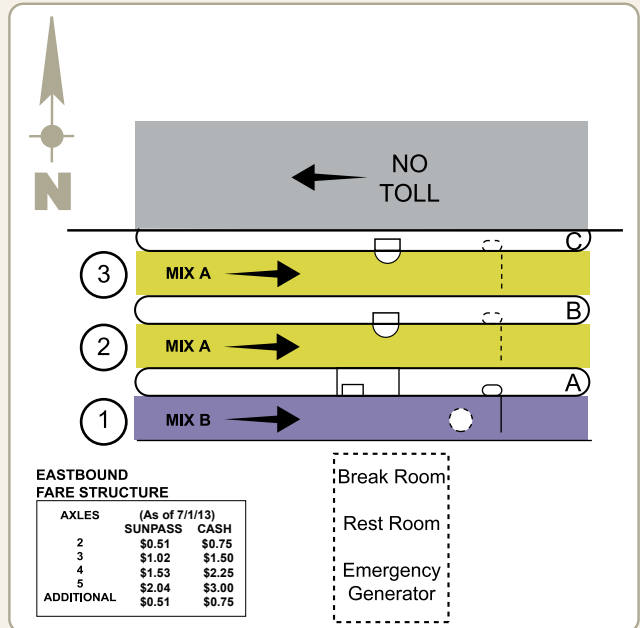

PINELLAS BAYWAY IV - PLAZA NO. 101320

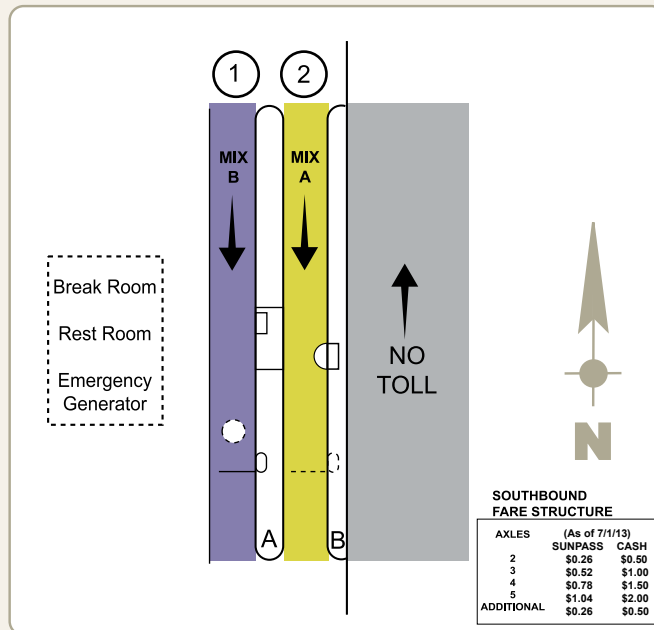

LEGEND

- DED:** Dedicated SunPass Lane
- MIX A:** Automatic Coin and SunPass Lane
- MIX B:** Manual Booth and SunPass Lane

SUNSHINE SKYWAY BRIDGE North and South Plazas

SKYWAY NORTH - PLAZA NO. 101400

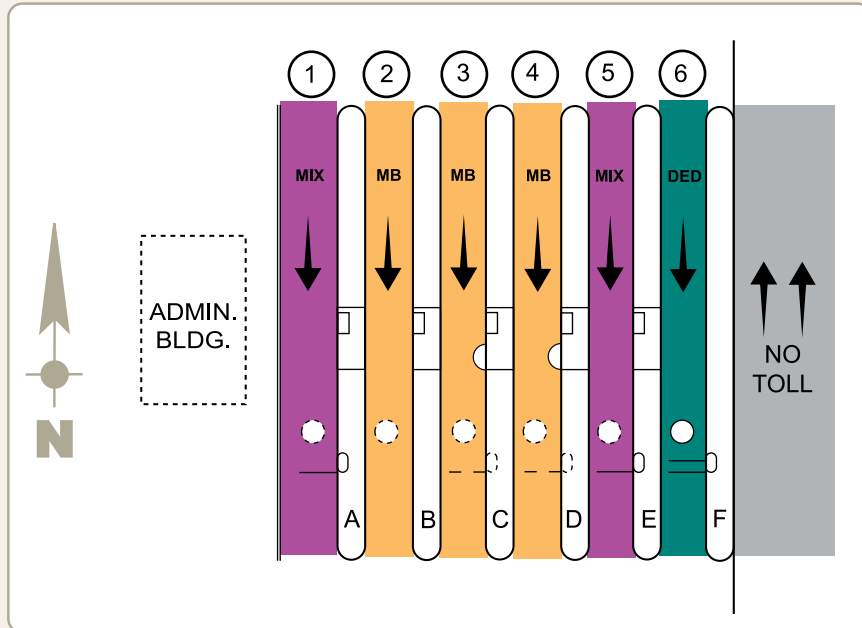

SKYWAY SOUTH - PLAZA NO. 101500

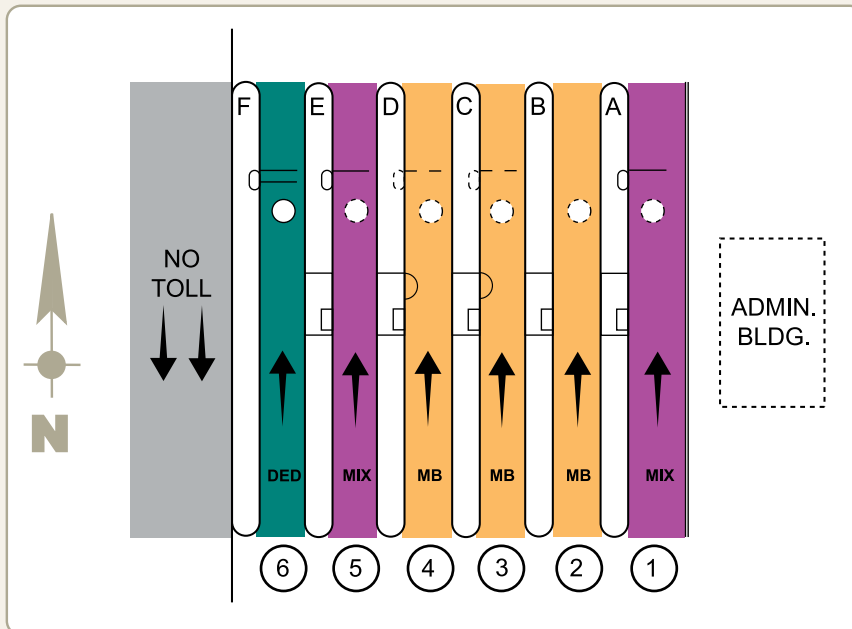

LEGEND

DED: Dedicated SunPass Lane
 MB: Manual Booth Lane
 MIX: Manual Booth and SunPass Lane

FARE STRUCTURE

AXLES	(As of 7/1/13)	
	SUNPASS	CASH
2	\$1.02	\$1.25
3	\$2.04	\$2.50
4	\$3.06	\$3.75
5	\$4.08	\$5.00
ADDITIONAL	\$1.02	\$1.25

95 EXPRESS

NW 54th STREET NORTHBOUND - PLAZA NO. 109610

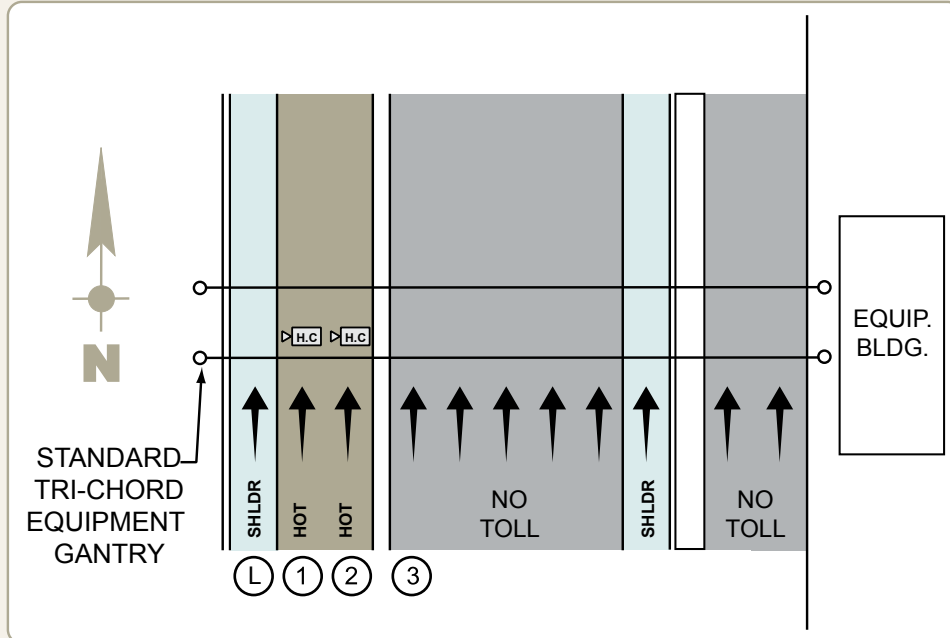

NW 144th STREET SOUTHBOUND - PLAZA NO. 109620

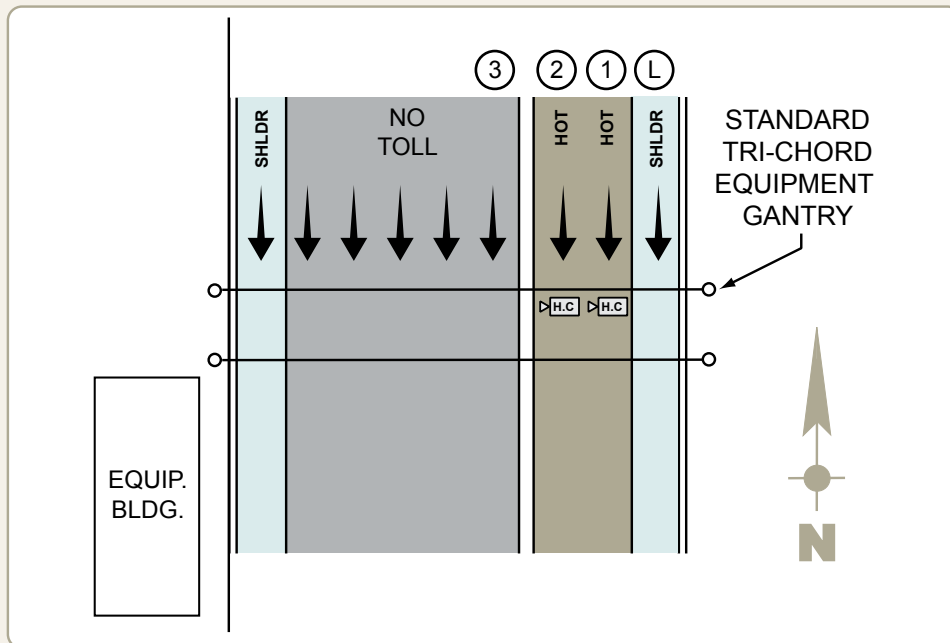

LEGEND

HOT: High Occupancy Toll

FARE STRUCTURE

ALL AXLE CLASSES	SUNPASS \$0.25*
------------------	--------------------

* Actual toll rate varies based on traffic density.

GARCON POINT BRIDGE

GARCON POINT BRIDGE - PLAZA NO. 101900

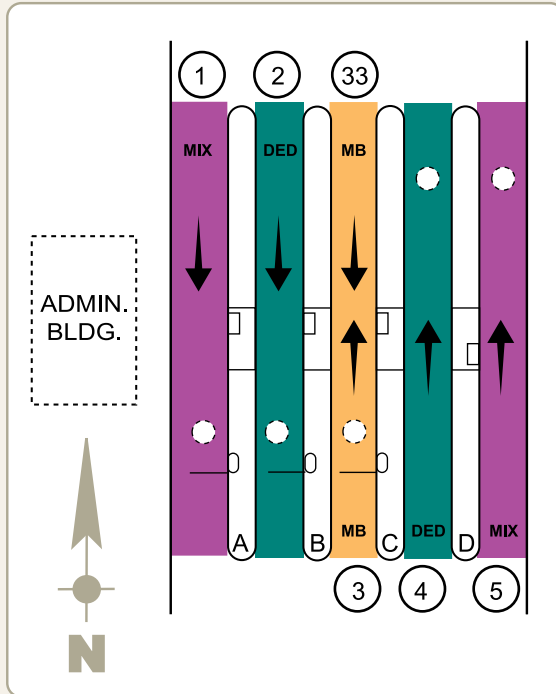

LEGEND

DED:	Dedicated SunPass Lane
MB:	Manual Booth Lane
MIX:	Manual Booth and SunPass Lane

FARE STRUCTURE

AXLES	SUNPASS AND CASH
2	\$3.75
3	\$7.50
4	\$11.25
5	\$15.00
ADDITIONAL	\$3.75

MID-BAY BRIDGE

MID-BAY BRIDGE - PLAZA NO. 101800

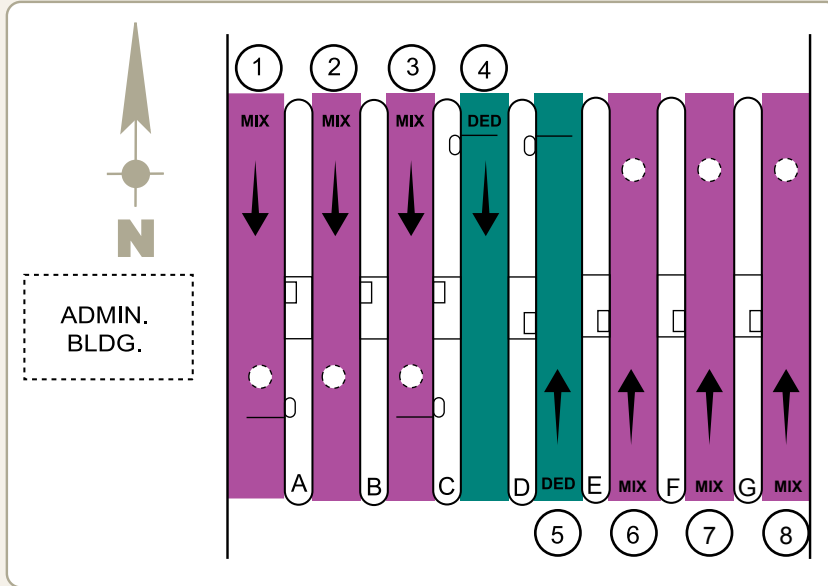

FARE STRUCTURE

AXLES	SUNPASS	CASH
2	\$2.00	\$3.00
3	\$6.00	\$6.00
4	\$9.00	\$9.00
5	\$12.00	\$12.00
ADDITIONAL	\$3.00	\$3.00

MID-BAY BRIDGE CONNECTOR - PLAZA NO. 101810

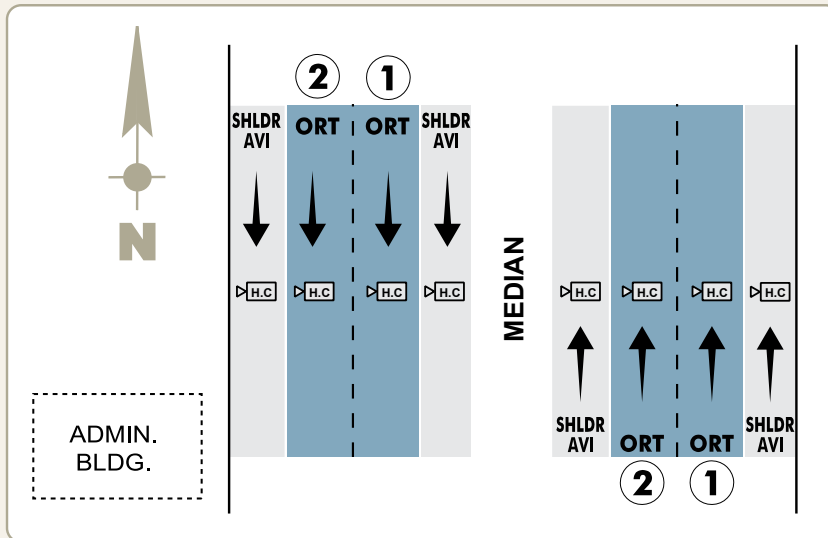

FARE STRUCTURE

AXLES	SUNPASS	TOLL-BY-PLATE
2	\$1.00	\$1.50
3	\$3.00	\$3.00
4	\$4.50	\$4.50
5	\$6.00	\$6.00
ADDITIONAL	\$1.50	\$1.50

LEGEND

- DED: Dedicated SunPass Lane
- MIX: Manual Booth and SunPass Lane
- ORT: Open Road Tolling Lane

THIS PAGE INTENTIONALLY LEFT BLANK